

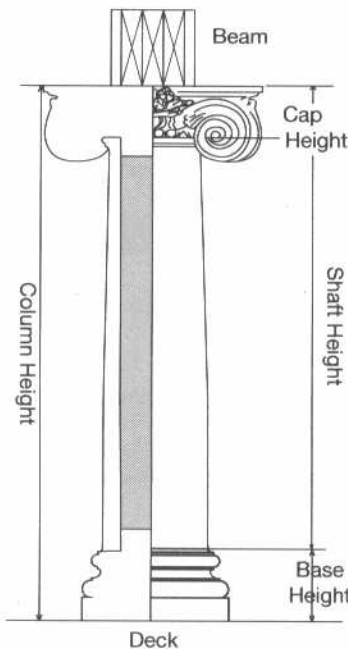

174 Sagamore Street
Somerset, PA 15501
(800) 242-7916
(814) 444-9427
(814) 443-1658 - FAX

Installation Instructions for StaveCast™ Composite Columns with Decorative Capitals



Tips for Easy Installation

Column may be trimmed with a carbide tipped saw. Fine trim with a rasp.

When installing column, be certain the load is distributed evenly over the bearing surface of the cap & base.

Painting tips: Use a 100 grit sandpaper to smooth surface. Clean column surface with a damp cloth, and allow to completely dry before painting. For best results apply a wood primer, then apply a high quality exterior latex paint.

CLEAN WITH A DAMP CLOTH
DO NOT USE OIL BASE PAINT
DO NOT WASH BEFORE PAINTING
KEEP DRY UNTIL PAINTED

1. Determine location for the column. Check levelness of deck. Measure from bottom of beam to deck (lowest point if deck is not level). Use a brace that is $\frac{1}{8}$ " taller than the column height to slightly raise the beam above the permanent column location.

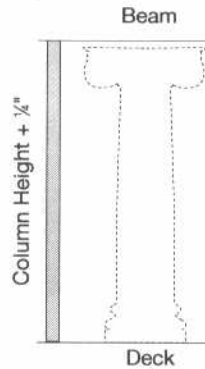

2. Trim top of shaft at lower bead with a carbide tipped saw.

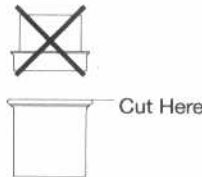

3. Subtract the height of the base from the column height and trim bottom of shaft.

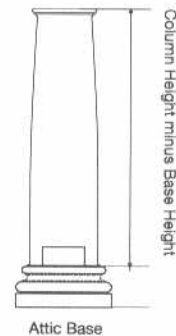

4. Test fit capital in the neck of shaft before permanent installation. If adjustment is needed use a rasp and grind evenly around circumference. Place capital on shaft. Stand the cap & shaft onto the base.
DO NOT FORCE CAPITAL INTO THE SHAFT.

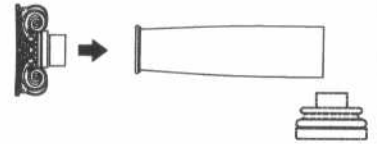

Note: Check level & plum. Base must be level and shaft must be plum. If deck is uneven use a rasp to trim bottom of shaft or base.

5. Apply construction adhesive, align cap & base, and remove brace. Pre-drill holes and attach cap to beam with two (2) screws. Pre-drill holes and attach base to deck with four (4) screws. Counter sink screws and fill holes with Bondo. Smooth with 100 grit sandpaper.

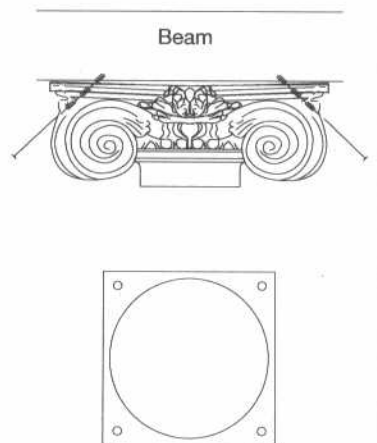

Made in Halves

1. Join halves with Bondo. Hold capital and base halves a few inches apart while Bondo is applied. Be certain there is complete contact along the joint, and fill any gaps at capital and base.

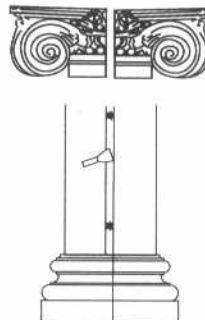

2. Place straps or ropes as clamps no more than 24" apart up height of the shaft. Tighten and let stand for 24 hours. Remove excess Bondo and smooth with 100 grit sandpaper. (Follow Bondo manufacturer's recommendations for clamping time under cool or moist conditions.)

